

**Innehåll**

<b>0202 Stålrör, galv</b>	<b>4</b>	Skarvrör, svart, sm	10
Rör, med muff	4	Nippelrör, svart, sm	10
<b>0203 Stålrör, blå</b>	<b>4</b>	Muff, svart, sm	10
Rör, blå, Wirsbo	4	Propp, svart, sm	11
<b>0205 Stålrör, elförzinkade</b>	<b>4</b>	Termometermuff, svart	11
Rör, elförzinkade	4	Skarvrör, galv, sm	11
<b>0206 Stålrördelar, elförz.</b>	<b>4</b>	Nippelrör, galv, sm	11
Vinkel, 1- muff, elförz.	4	Muff, galv, sm	11
Vinkel, 2- muff, elförz.	4	<b>0211 Stålrördelar, ad, svart</b>	<b>11</b>
Språng, 1- muff, elförz.	4	Rak koppling, inv g, svart	11
Språng, 2- muff, elförz.	4	Rak koppling, inv x utv g sv	11
Språng, 1- muff x utv g, elförz.	5	Knärör, inv x utv g, svart	11
T-rör, elförz.	5	Knärör, inv g, svart	11
T-rör, avstick, inv g, elförz.	5	Språng, inv x utv g, svart	11
Skarvmuff, elförz.	6	Språng, inv g, svart	12
Skjutmuff, elförz.	6	Vinkel, inv g, svart	12
Överg press x svetsände, elförz.	6	Vinkel, inv x utv g, svart	12
S- rör, elförz.	6	T-rör, inv g, svart	12
Förbigångsrör, elförz.	6	Förminskningsmuff, inv g, sv	12
Propp, elförz.	6	D-nippel, utv g, svart	12
Förminskning, elförz.	6	Bussning, ut x inv g, svart	13
Övergångsmuff, utv g, elförz.	7	Propp, utv g, svart	13
Övergångsmuff, inv g, elförz.	7	Huv, inv g, svart	13
Överg nipp, slät x inv g, elförz.	7	<b>0211 Stålrördelar, ad, galv</b>	<b>13</b>
Kpl muff, 1- muff, i nv g, elförz.	7	Rak koppling, inv g, galv	13
Stamfördelare, elförzink, enkel.	7	Rak kpn, inv x utv g, galv	13
Stamfördelare, elförz, dubbel.	7	Knärör, inv x utv g, galv	13
Stamfördelare, elförzinkad, DT.	7	Knärör, inv g, galv	13
<b>0207 Stålrör elförzinkade, Mapress</b>	<b>8</b>	Språng, inv x utv g, galv	13
<b>0208 Stålrördelar elförzinkade, Mapress</b>	<b>8</b>	Språng, inv g, galv	14
Vinkel, 1-muff, elförzinkad	8	Vinkel, inv g, galv	14
Vinkel, 2-muff, elförzinkad	8	Vinkel, inv x utv g, galv	14
Språng, 1-muff, elförzinkad	8	T-rör, inv g, galv	14
Språng, 2-muff, elförzinkad	8	Förm. muff, inv g, galv	14
Vinkel, 1-muff, x utv g, elförzinkad	8	D-nippel, utv g, galv	14
T-rör, elförzinkad	9	Bussning, ut x inv g, galv	15
T-rör, m avstick, utv g, elförzinkad	9	Propp, utv g, galv	15
Skarvmuff, elförzinkad	9	Huv, inv g, galv	15
Skjutmuff, elförzinkad	9	<b>0220 Tubrör</b>	<b>15</b>
S- rör, elförzinkad	9	Tubrör, tryckkärlekskvalitet	15
Huv, elförzinkad	9	Tubrör, handelskvalitet	15
Förminskning, elförzinkad	10	<b>0221 Tubrördelar</b>	<b>15</b>
Övergångsmuff utv g, elförzinkad	10	Tubböj, tryckkärlekskvalitet	15
Övergångsmuff inv g, elförzinkad	10	Tubböj, handelskvalitet	15
Övergångsnippel inv g, elförzinkad	10	Svetskona	15
Koppling, 1-muff x inv g, elförzinkad	10	Tub T-rör	15
<b>0210 Stålrördelar, smidda</b>	<b>10</b>	Tub kupad gavel	15
		<b>0230 Flänsar</b>	<b>16</b>
		Gängfläns, PN 16, galv	16

---

Svetsfläns med krage, PN 6	16
Svetsfläns med krage, PN 16	16
Stålmetsallfläns, CU	16
<b>0232 Flänspack, asbestfri</b>	<b>16</b>
Flänspackning, PN 40	16
Flänspackning, PN 16	16
Flänspackning, PN 6	16
<b>0250 Reparationskoppling</b>	<b>16</b>
Reparationskoppling inv g	16
Reparationskoppling utv g	16
Reparationskoppling inv g	17
Reparationskoppling utv g	17
<b>0260 T-plus för stålrör</b>	<b>17</b>
<b>Flänsguide</b>	<b>18</b>
<b>Flänspackningar, guide</b>	<b>22</b>

## Geberit Mapress Elförzinkat stål



När det gäller det snabbaste, enklaste och säkraste sättet att förbinda rör är Geberit Mapress Elförzinkade pressrörssystem marknadsledande. Kapa röret till rätt längd, grada av, för på pressrördelen, pressa – klart. Med fler än 400 olika pressrördelar och anpassade systemrör att välja mellan är det bland marknadens bredaste sortiment. Den patenterade O-ringen och pressindikatorn ger extra säkerhet i arbetet. Således kan opressade rördelar lätt upptäckas redan innan provtryckningen utförts. Varför göra saker krångligt, när det finns ett lättare sätt? Det är vad vi menar med "Know How Installed".

[www.geberit.se](http://www.geberit.se)

**GEBERIT**

## 0202 Stålrör, galv

Rör, med muff

Art nr	Dim
1222033	15
1222041	20
1222058	25
1222066	32
1222074	40
1222082	50

## 0203 Stålrör, blå

Rör, blå, Wirsbo

Art nr	Dim
1221200	10
1221201	15
1221202	20
1221203	25
1221204	32
1221205	40
1221206	50

## 0205 Stålrör, elförzinkade

Rör, elförzinkade

Art nr	Dim
1550456	12
1550457	15
1550458	18
1550459	22
1550460	28
1550461	35
1550462	42
1550463	54

## 0206 Stålrördelar, elförz.

Godkänd pressback till Elförzinkade stålrördelar är M- back. (Se flik 26).

Tubman/Chibro elförzinkade rördelar sammanfogas med galvaniserade precisionsrör med mått och toleranser enligt DIN 2394. Systemet används främst till värmeinstallationer men också inom ett flertal andra områden såsom t ex.: slutna kylvattensystem, system för tryckluft eller ädelgaser, sprinklersystem, vacuum-system

Arbetstemperatur: -20°/+120°C

Max arbetstryck: 16 bar

Max undertryck: -0.95 bar

Typ av pressbackar: M

Arbetstemperatur för rörsystem med plastbelagda rör: -20/+95°C

### Vinkel, 1- muff, elförz.



Art nr	Dim
1555033	12
1555034	15
1555035	18
1555036	22
1555037	28
1555244	35
1555245	42
1555246	54

### Vinkel, 2- muff, elförz.



Art nr	Dim
1555022	12
1555023	15
1555024	18
1555025	22
1555026	28
1555238	35
1555239	42
1555240	54

### Språng, 1- muff, elförz.



Art nr	Dim
1555054	15
1555055	18
1555056	22
1555057	28
1555247	35
1555248	42
1555249	54

### Språng, 2- muff, elförz.



Art nr	Dim
1555044	15
1555045	18
1555046	22
1555047	28
1555241	35
1555242	42
1555243	54

**Språng, 1- muff x utv g,  
elförz.**

Art nr	Dim
1555186	12 x R10
1555187	15 x R10
1555188	15 x R15
1555189	18 x R15
1555190	22 x R20
1555191	28 x R25
1555192	35 x R32
1555193	42 x R40
1555194	54 x R50

**T-rör, elförz.**

Art nr	Dim
1555104	12
1555105	15
1555106	18
1555107	22
1555108	28
1555109	35
1555110	42
1555111	54
1555138	12 x 15
1555115	15 x 12
1555140	15 x 22
1555116	18 x 12
1555117	18 x 15
1555118	22 x 12
1555119	22 x 15
1555120	22 x 18
1555121	28 x 15
1555122	28 x 18
1555123	28 x 22
1555124	35 x 15
1555125	35 x 18
1555126	35 x 22
1555127	35 x 28
1555128	42 x 22
1555129	42 x 28
1555130	42 x 35
1555131	54 x 22
1555132	54 x 28
1555133	54 x 35
1555134	54 x 42

**T-rör, avstick, inv g, elförz.**

Art nr	Dim
1555143	12 x R10
1555144	12 x R15
1555145	15 x R15
1555146	18 x R15
1555147	22 x R15
1555148	28 x R15
1555149	35 x R15
1555150	35 x R20
1555151	42 x R15
1555152	42 x R20
1555153	54 x R15
1555154	54 x R20

## Skarvmuff, elförz.



Art nr	Dim
1555000	12
1555001	15
1555002	18
1555003	22
1555004	28
1555005	35
1555006	42
1555007	54

## Skjutmuff, elförz.



Art nr	Dim
1555011	12
1555012	15
1555013	18
1555014	22
1555015	28
1555016	35
1555017	42
1555018	54

## Överg press x svetsände, elförz.



För sammanfogning tjockväggiga stålrör och precisionstålrör typ RSK 155 04 56 etc. med svetsning samt pressverktyg.

Art nr	Dim
1555195	15 x 12
1555196	17 x 15
1555197	20 x 18
1555198	24 x 22
1555199	31 x 28
1555200	38 x 35
1555223	44 x 42
1555201	57 x 54

## S- rör, elförz.



Art nr	Dim
1555064	12
1555065	15
1555066	18
1555067	22
1555068	28

## Förbigångsrör, elförz.



Art nr	Dim
1555069	12
1555070	15
1555071	18
1555072	22
1555073	28

## Propp, elförz.



Art nr	Dim
1555212	12
1555213	15
1555214	18
1555215	22
1555216	28
1555217	35
1555218	42
1555219	54

## Förminskning, elförz.



Art nr	Dim
1555074	15 x 12
1555075	18 x 12
1555077	18 x 15
1555076	22 x 12
1555078	22 x 15
1555080	22 x 18
1555079	28 x 15
1555081	28 x 18
1555082	28 x 22
1555236	35 x 18
1555083	35 x 22
1555084	35 x 28
1555237	42 x 22
1555085	42 x 28
1555086	42 x 35
1555225	54 x 22
1555087	54 x 28
1555088	54 x 35
1555089	54 x 42

**Övergångsmuff, utv g, elförz.**

Art nr	Dim
1555155	12 x R10
1555156	15 x R10
1555157	15 x R15
1555158	18 x R15
1555159	18 x R20
1555160	22 x R20
1555161	28 x R25
1555162	35 x R32
1555163	42 x R40
1555164	54 x R50

**Övergångsmuff, inv g, elförz.**



Art nr	Dim
1555180	15 x R15
1555181	18 x R15
1555182	18 x R20
1555183	22 x R20
1555184	28 x R20
1555185	28 x R25

**Överg nipp, slät x inv g, elförz.**

Art nr	Dim
1555165	12 x R15
1555167	15 x R15
1555168	18 x R15
1555169	18 x R20
1555170	22 x R15
1555171	22 x R20

**Kpl muff, 1- muff, i nv g, elförz.**

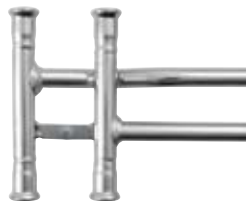
Art nr	Dim
1555172	15 x R20
1555173	18 x R20
1555174	22 x R25
1555175	28 x R32
1555176	35 x R40
1555177	42 x R50
1555178	54 x R50

**Stamfördelare, elförzink, enkel.**

Art nr	Dim
1550887	15 x 15
1550890	22 x 12
1550891	22 x 15
1550892	28 x 12
1550893	28 x 15

**Stamfördelare, elförz, dubbel.**

Art nr	Dim
1551056	15 x 15
1551059	22 x 12
1551060	22 x 15
1551061	28 x 12
1551062	28 x 15

**Stamfördelare, elförzinkad, DT.**

Art nr	Dim
1551155	22 x 12
1551156	22 x 15
1551157	28 x 12
1551158	28 x 15

## 0207 Stålrör elförzinkade, Mapress

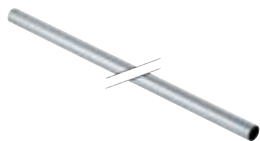

Art nr	Dim
1550848	12
1550849	15
1550850	18
1550851	22
1550852	28
1550853	35
1550854	42
1550855	54

## 0208 Stålrördelar elförzin- kade, Mapress

### Vinkel, 1-muff, elförzinkad



Art nr	Dim
1551085	12
1551086	15
1551087	18
1551088	22
1551089	28
1551090	35
1551091	42
1551092	54

### Vinkel, 2-muff, elförzinkad



Art nr	Dim
1550900	12
1550901	15
1550902	18
1550903	22
1550904	28
1550905	35
1550906	42
1550907	54

### Språng, 1-muff, elförzinkad



Art nr	Dim
1551093	15
1551094	18
1550930	22
1550931	28
1550932	35
1550933	42
1550934	54

### Språng, 2-muff, elförzinkad



Art nr	Dim
1551095	15
1551096	18
1550935	22
1550936	28
1550937	35
1550938	42
1550939	54

### Vinkel, 1-muff, x utv g, elför- zinkad



Art nr	Dim
1550925	12 x R10
1550926	15 x R10
1550927	15 x R15
1550928	18 x R15
1550929	22 x R20
1552647	28 x R25

**T-rör, elförzinkad**

**Art nr Dim**

1550940	12
1550941	15
1550942	18
1550943	22
1550944	28
1550945	35
1550946	42
1550947	54
1550975	12 x 15
1550948	15 x 12
1550979	15 x 22
1550949	18 x 12
1550950	18 x 15
1550956	22 x 12
1550951	22 x 15
1550952	22 x 18
1550953	28 x 15
1550954	28 x 18
1550955	28 x 22
1550957	35 x 15
1550958	35 x 18
1550959	35 x 22
1550966	35 x 28
1550965	42 x 22
1550964	42 x 28
1550960	42 x 35
1550967	54 x 22
1550963	54 x 28
1550962	54 x 35
1550961	54 x 42

**T-rör, m avstick, utv g, elförzinkad**

**Art nr Dim**

1550527	12 x R10
1550528	12 x R15
1550968	15 x R15
1550969	18 x R15
1550970	22 x R15
1550971	28 x R15
1550972	35 x R15
1550529	35 x R20
1550973	42 x R15
1550519	42 x R20
1550974	54 x R15
1550520	54 x R20

**Skarvmuff, elförzinkad**

**Art nr Dim**

1551002	12
1551003	15
1551004	18
1551005	22
1551006	28
1551007	35
1551008	42
1551009	54

**Skjutmuff, elförzinkad**

**Art nr Dim**

1551010	12
1551011	15
1551012	18
1551013	22
1551014	28
1551015	35
1551016	42
1551017	54

**S- rör, elförzinkad**

**Art nr Dim**

1551049	12
1551050	15
1551051	18
1551052	22
1551053	28

**Huv, elförzinkad**

**Art nr Dim**

1552222	12
1552223	15
1552224	18
1552225	22
1552226	28
1552227	35
1552228	42
1552229	54

## Förminskning, elförzinkad



Art nr	Dim
1550989	15 x 12
1550990	18 x 12
1550992	18 x 15
1550991	22 x 12
1550993	22 x 15
1550994	28 x 15
1550996	28 x 18
1550997	28 x 22
1550556	35 x 18
1550998	35 x 22
1550999	35 x 28
1550617	42 x 22
1550618	42 x 28
1551000	42 x 35
1550619	54 x 22
1550579	54 x 28
1550620	54 x 35
1551001	54 x 42

## Övergångsmuff utv g, elförzinkad



Art nr	Dim
1551018	12 x R10
1551020	15 x R15
1551021	18 x R15
1551022	18 x R20
1551023	22 x R20
1551024	28 x R25
1551025	35 x R32
1551026	42 x R40
1551027	54 x R50

## Övergångsmuff inv g, elförzinkad



Art nr	Dim
1551029	15 x R15
1551030	18 x R15
1551031	18 x R20
1551032	22 x R20
1551033	28 x R25

## Övergångsnippel inv g, elförzinkad



Art nr	Dim
1551034	12 x R15
1551035	15 x R15
1551036	18 x R15
1551037	18 x R20
1551038	22 x R15
1551039	22 x R20

## Koppling, 1-muff x inv g, elförzinkad



Art nr	Dim
1550861	15 x R20
1550862	22 x R25
1550863	28 x R32
1550864	35 x R40
1550865	42 x R40

## 0210 Stålrördelar, smidda

### Skarvrör, svart, sm



Art nr	Dim
1241025	10
1241033	15
1241041	20
1241058	25
1241066	32
1241074	40
1241082	50

### Nippelrör, svart, sm



Art nr	Dim
1241629	10
1241637	15
1241645	20
1241652	25
1241660	32
1241678	40
1241686	50

### Muff, svart, sm

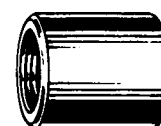

Art nr	Dim
1246016	8
1246024	10
1246032	15
1246040	20
1246057	25
1246065	32
1246073	40
1246081	50

**Propp, svart, sm**



Art nr	Dim
1248731	15

**Termometermuff, svart**

Art nr	Dim/L= mm
5138813	15 x 60

**Skarvrör, galv, sm**

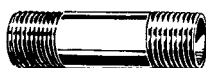

Art nr	Dim
1241181	15
1241199	20
1241207	25
1241215	32
1241223	40
1241231	50

**Nippelrör, galv, sm**

Art nr	Dim
1241785	15
1241793	20
1241801	25
1241819	32
1241827	40
1241835	50

**Muff, galv, sm**

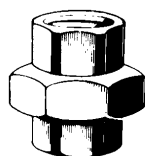

Art nr	Dim
1246180	15
1246198	20
1246206	25
1246214	32
1246222	40
1246230	50
1246248	65

**0211 Stålrördelar, ad, svart**
**Rak koppling, inv g, svart**

Art nr	Dim
1260637	15
1260645	20
1260652	25
1260660	32
1260678	40
1260686	50

**Rak koppling, inv x utv g sv**

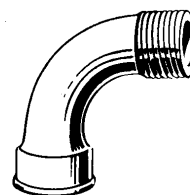
Art nr	Dim
1260926	10
1260934	15
1260942	20
1260959	25
1260967	32
1260975	40
1260983	50

**Knärör, inv x utv g, svart**

Art nr	Dim
1265024	10
1265032	15
1265040	20
1265057	25
1265065	32
1265073	40
1265081	50

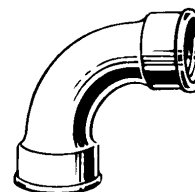
**Knärör, inv g, svart**

Art nr	Dim
1265321	10
1265339	15
1265347	20
1265354	25
1265362	32
1265370	40
1265388	50

**Språng, inv x utv g, svart**

Art nr	Dim
1266022	10
1266030	15
1266048	20
1266055	25
1266063	32
1266071	40
1266089	50

## Språng, inv g, svart

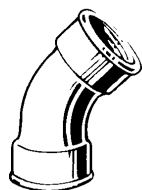

Art nr	Dim
1266329	10
1266337	15
1266345	20
1266352	25
1266360	32
1266378	40
1266386	50

## Vinkel, inv g, svart



Art nr	Dim
1270016	8
1270024	10
1270032	15
1270040	20
1270057	25
1270065	32
1270073	40
1270081	50
1270438	25 x 15

## Vinkel, inv x utv g, svart

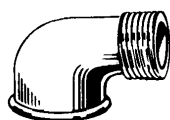

Art nr	Dim
1271311	8
1271329	10
1271337	15
1271345	20
1271352	25
1271360	32
1271378	40
1271386	50

## T-rör, inv g, svart

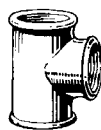

Art nr	Dim
1276021	10
1276039	15
1276047	20
1276054	25
1276062	32
1276070	40
1276088	50

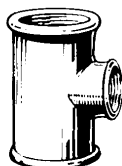

Art nr	Dim
1276526	20 x 15
1276609	25 x 15
1276617	25 x 20
1276690	32 x 15
1276716	32 x 25
1276781	40 x 15
1276880	50 x 15

## Förminskningsmuff, inv g, sv



Art nr	Dim
1313253	15 x 10
1313295	20 x 15
1313337	25 x 15
1313345	25 x 20
1313402	32 x 25

## D-nippel, utv g, svart

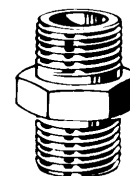

Art nr	Dim
1316314	8
1316322	10
1316330	15
1316348	20
1316355	25
1316363	32
1316371	40
1316389	50

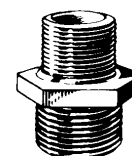

Art nr	Dim
1316827	10 x 8
1316843	15 x 8
1316850	15 x 10

1316884	20 x 10
1316892	20 x 15

1316934	25 x 15
1316942	25 x 20

1316983	32 x 15
1316991	32 x 20
1317007	32 x 25

1317056	40 x 20
---------	---------

1317064	40 x 25
1317072	40 x 32

1317130	50 x 25
1317148	50 x 32
1317155	50 x 40

**Bussning, ut x inv g, svart**

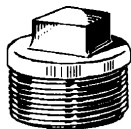

Art nr	Dim
1318203	8 x 6
1318229	10 x 8
1318245	15 x 8
1318252	15 x 10
1318286	20 x 10
1318294	20 x 15
1318328	25 x 10
1318336	25 x 15
1318344	25 x 20
1318377	32 x 10
1318385	32 x 15
1318393	32 x 20
1318401	32 x 25
1318443	40 x 15
1318450	40 x 20
1318468	40 x 25
1318476	40 x 32
1318518	50 x 15
1318526	50 x 20
1318534	50 x 25
1318542	50 x 32
1318559	50 x 40

**Propp, utv g, svart**

Art nr	Dim
1320027	10
1320035	15
1320043	20
1320050	25
1320068	32
1320076	40
1320084	50

**Huv, inv g, svart**

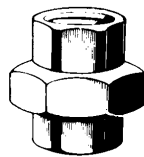

Art nr	Dim
1328913	10
1328921	15
1328939	20
1328947	25
1328954	32
1328962	40
1328970	50

**0211 Stålrördelar, ad, galv**
**Rak koppling, inv g, galv**

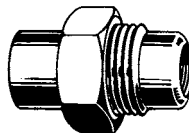
Art nr	Dim
1260785	15
1260793	20
1260801	25
1260819	32
1260827	40
1260835	50

**Rak kpn, inv x utv g, galv**

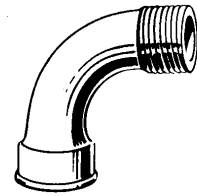
Art nr	Dim
1261080	15
1261098	20
1261106	25
1261114	32
1261122	40
1261130	50

**Knärör, inv x utv g, galv**

Art nr	Dim
1265180	15
1265198	20
1265206	25
1265214	32
1265222	40
1265230	50

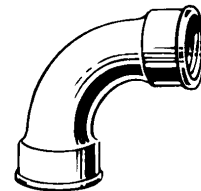
**Knärör, inv g, galv**

Art nr	Dim
1265487	15
1265495	20
1265503	25
1265511	32
1265529	40
1265537	50

**Språng, inv x utv g, galv**

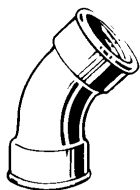

Art nr	Dim
1266188	15
1266196	20
1266204	25
1266212	32
1266220	40
1266238	50

## Språng, inv g, galv

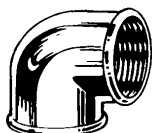

Art nr	Dim
1266485	15
1266493	20
1266501	25
1266519	32
1266527	40
1266535	50

## Vinkel, inv g, galv



Art nr	Dim
1270180	15
1270198	20
1270206	25
1270214	32
1270222	40
1270230	50

## Vinkel, inv x utv g, galv

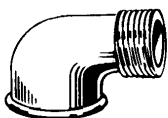

Art nr	Dim
1271485	15
1271493	20
1271501	25
1271519	32
1271527	40
1271535	50

## T-rör, inv g, galv

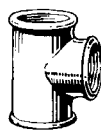

Art nr	Dim
1276179	10
1276187	15
1276195	20
1276203	25
1276211	32
1276229	40
1276237	50

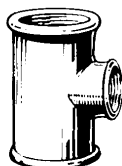

Art nr	Dim
1277821	20 x 15
1277904	25 x 15
1277912	25 x 20
1277995	32 x 15
1278019	32 x 25
1278084	40 x 15
1278183	50 x 15

## Förm. muff, inv g, galv



Art nr	Dim
1314137	25 x 15

## D-nippel, utv g, galv

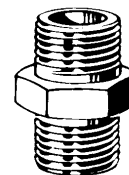

Art nr	Dim
1316462	8
1316470	10
1316488	15
1316496	20
1316504	25
1316512	32
1316520	40
1316538	50

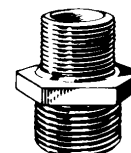

Art nr	Dim
1317528	10 x 8
1317544	15 x 8
1317551	15 x 10
1317585	20 x 10
1317593	20 x 15
1317635	25 x 15
1317643	25 x 20
1317684	32 x 15
1317692	32 x 20
1317700	32 x 25
1317767	40 x 25
1317775	40 x 32

**Bussning, ut x inv g, galv**

Art nr	Dim
1319128	10 x 8
1319144	15 x 8
1319151	15 x 10
1319185	20 x 10
1319193	20 x 15
1319227	25 x 10
1319235	25 x 15
1319243	25 x 20
1319276	32 x 10
1319284	32 x 15
1319292	32 x 20
1319300	32 x 25
1319342	40 x 15
1319359	40 x 20
1319367	40 x 25
1319375	40 x 32
1319417	50 x 15
1319425	50 x 20
1319433	50 x 25
1319441	50 x 32
1319458	50 x 40
1319532	65 x 50

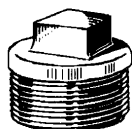
**Propp, utv g, galv**

Art nr	Dim
1320167	8
1320175	10
1320183	15
1320191	20
1320209	25
1320217	32
1320225	40
1320233	50

**Huv, inv g, galv**

Art nr	Dim
1329119	15
1329127	20
1329135	25
1329143	32
1329150	40
1329168	50

**0220 Tubrör**
**Tubrör, tryckkärlskvalitet**

Art nr	Dim
1351030	33,7
1351436	42,4
1351832	48,3
1352442	60,3
1353044	76,1
1353457	88,9
1354265	114,3

**Tubrör, handelskvalitet**

Art nr	Dim
1341163	33,7
1341189	42,4
1341205	48,3
1341239	60,3
1341262	76,1
1341288	88,9
1341312	114,3

**0221 Tubrördelar**
**Tubböj, tryckkärlskvalitet**

Art nr	Dim
1370584	26,9
1370931	33,7
1371137	42,4
1371335	48,3
1371640	60,3
1371947	76,1
1372259	88,9
1372663	114,3

**Tubböj, handelskvalitet**

Art nr	Dim
1342138	26,9
1342161	33,7
1342187	42,4
1342203	48,3
1342237	60,3
1342260	76,1
1342286	88,9
1342310	114,3

**Svetskona**

Art nr	Dim
1410661	33,7/21,3
1410679	33,7/26,9
1410711	42,4/26,9
1410729	42,4/33,7
1410802	48,3/33,7

1410810	48,3/42,4
1410893	60,3/33,7
1410901	60,3/42,4
1410927	60,3/48,3
1411008	76,1/48,3

1411024	76,1/60,3
1411073	88,9/60,3
1411081	88,9/76,1
1411206	114,3/76,1
1411214	114,3/88,9

**Tub T-rör**

Art nr	Dim x t
1414614	33,7 x 2,6
1414622	42,4 x 2,6
1414630	48,3 x 2,6
1414655	60,3 x 2,9
1414671	76,1 x 2,9
1414689	88,9 x 3,2
1414713	114,3 x 3,6

**Tub kupad gavel**

Art nr	Dim
1414960	33,7
1414978	42,4
1414986	48,3
1415009	60,3
1415017	76,1
1415025	88,9
1415033	114,3

## 0230 Flänsar

Gängfläns, PN 16, galv

Se Flänsguide i slutet på fliken.

Art nr	Dim
1420660	32
1420678	40
1420686	50

Svetsfläns med krage, PN 6

Se Flänsguide i slutet på fliken.

Art nr	Dim
1422088	33,7
1422104	42,4
1422120	48,3
1422146	60,3
1422153	76,1
1422161	88,9
1422203	114,3

Svetsfläns med krage, PN 16

Se Flänsguide i slutet på fliken.

Art nr	Dim
1423086	33,7
1423102	42,4
1423128	48,3
1423144	60,3
1423151	76,1
1423169	88,9
1423219	114,3

Stålmetsallfläns, CU

Se Flänsguide i slutet på fliken.

Art nr	Dim
1485903	15
1485937	22
1485945	28
1485952	35
1485978	42
1485986	54
1486000	76
1486042	89

## 0232 Flänspack, asbestfri

Flänspackning, PN 40

Se guide i slutet på fliken.

Art nr	Dim
1504901	15
1504902	20
1504903	25
1504904	32
1504905	40
1504906	50
1504907	65
1504908	80

Flänspackning, PN 16

Se guide i slutet på fliken.

Art nr	Dim
1504909	100
1504910	125
1504911	150
1504913	200
1504914	250

Flänspackning, PN 6

Se guide i slutet på fliken.

Art nr	Dim
1504888	20
1504889	25
1504890	32
1504891	40
1504895	100

## 0250 Reparationskoppling

Reparationskoppling inv g



**Frese 40-1111 Stålrörskoppling**  
Inv/DN PN16. För stålrör SMS 326.  
Max 120°C

Art nr	Dim
1541009	10
1541010	15
1541028	20
1541036	25
1541044	32
1541045	40
1541046	50

Reparationskoppling utv g



**Frese 40-1113 Stålrörskoppling**  
Utv gg PN16. För stålrör SMS 326.  
Max 120°C,

Art nr	Dim
1541000	10
1541001	15
1541002	20
1541003	25
1541004	32
1541005	40
1541006	50

## VATEK UNIFLEX koppling ger dig följande fördelar.

Dragfast.

Kraftig gummipackning som fungerar även på utvändigt korroderade rör.

Långt insticksdjup förenklar montage i befintliga installationer.

Kraftig konstruktion av aducerjärn, dubbelt galvaniserad – före och efter bearbetning.

Kraftig gummipackning av NBR-gummi för vatten, gas, olja och bensin.

Inspänningsfritt montage med möjlighet att välja montering med eller utan avvinkling på dim. DN 1/2"-2", större

dim. endast med avvinkling.

Tryckklass PN 10/vatten.

### Reparationskoppling inv g

Art nr	Dim
1541321	15
1541322	20
1541323	25
1541324	32
1541286	40
1541287	50

### Reparationskoppling utv g

Art nr	Dim
1541319	15
1541279	20
1541280	25
1541281	32
1541282	40
1541283	50

## 0260 T-plus för stålrör



Art nr	Dim
1540400	15 x R15
1540418	20 x R15
1540426	25 x R20
1540434	32 x R25
1540459	40 x R32
1540475	50 x R32

## Flänsguide

### Gängflänsar

material St.37, galv

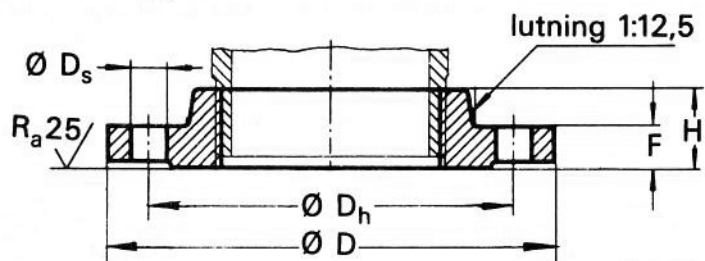

Ansl DN	D mm	Dh mm	F mm	H mm	Skruvhål st	Ds mm	Skruv gänga	Skruv längd/mm	Vikt kg/st	RSK-nr
------------	---------	----------	---------	---------	----------------	----------	----------------	-------------------	---------------	--------

■ Enligt SS 347 PN 6

10	75	50	12	20	4	11	M10	40	0,3	142 02 23
15	80	55	12	20	4	11	M10	40	0,4	142 02 31
20	90	65	14	24	4	11	M10	45	0,6	142 02 49
25	100	75	14	24	4	11	M10	45	0,7	142 02 56
32	120	90	14	26	4	14	M12	50	1,0	142 02 64
40	130	100	14	26	4	14	M12	50	1,2	142 02 72
50	140	110	14	28	4	14	M12	50	1,4	142 02 80
65	160	130	14	32	4	14	M12	50	2,0	142 02 98
80	190	150	16	34	4	18	M16	60	2,9	142 03 06
100	210	170	16	38	4	18	M16	60	3,2	142 03 22

■ Enligt SS 348 PN 16

10	90	60	14	20	4	14	M12	50	0,5	142 06 29
15	95	65	14	20	4	14	M12	50	0,6	142 06 37
20	105	75	16	24	4	14	M12	50	0,9	142 06 45
25	115	85	16	24	4	14	M12	50	1,1	142 06 52
32	140	100	16	26	4	18	M16	60	1,6	142 06 60
40	150	110	16	26	4	18	M16	60	1,8	142 06 78
50	165	125	18	28	4	18	M16	60	2,5	142 06 86
65	185	145	18	32	4	18	M16	60	3,2	142 06 94
80	200	160	20	34	8	18	M16	65	4,1	142 07 02
100	220	180	20	38	8	18	M16	65	4,5	142 07 28

## Flänsguide

### Svetsflänsar med krage

Certifikat kan om så önskas erhållas på flänsar PN 10, PN 16, PN 25, PN 40, PN 64 och PN 100. Detta måste i så fall begäras vid beställningstillfället.

#### Enligt SS 2031 PN 6

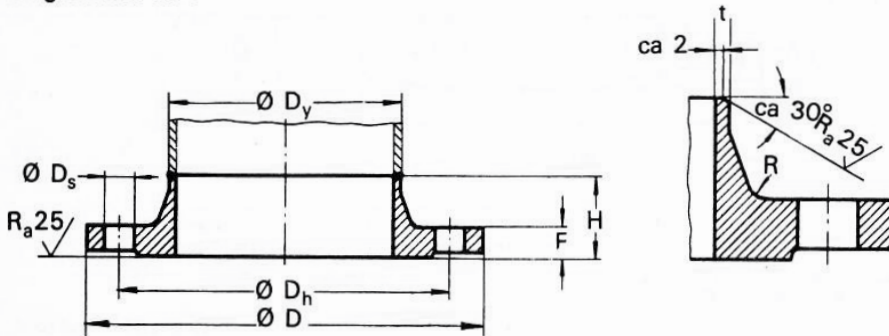

Ansl DN	Dy mm	t mm	D mm	Dh mm	F mm	H mm	Skruvhål st	Ds mm	Skruv gänga	Skruv längd/mm	Vikt kg/st	RSK-nr
<b>■ Av stål SS 1430 eller St 37.2</b>												
10	17,2	1,8	75	50	12	28	4	11	M10	40	0,3	142 20 21
15	21,3	2,0	80	55	12	30	4	11	M10	40	0,4	142 20 47
20	26,9	2,3	90	65	14	32	4	11	M10	45	0,6	142 20 62
25	33,7	2,6	100	75	14	35	4	11	M10	45	0,8	142 20 88
32	42,4	2,6	120	90	14	35	4	14	M12	50	1,0	142 21 04
40	48,3	2,6	130	100	14	38	4	14	M12	50	1,2	142 21 20
50	60,3	2,9	140	110	14	38	4	14	M12	50	1,3	142 21 46
65	76,1	2,9	160	130	14	38	4	14	M12	50	1,7	142 21 53
80	88,9	3,2	190	150	16	42	4	18	M16	60	2,7	142 21 61
100	114,3	3,6	210	170	16	45	4	18	M16	60	3,2	142 22 03
125	139,7	4,0	240	200	18	48	8	18	M16	65	4,5	142 22 37
150	168,3	4,5	265	225	18	48	8	18	M16	65	5,1	142 22 52
200	219,1	6,3	320	280	20	55	8	18	M16	65	7,8	142 22 86
250	273,0	6,3	375	335	22	60	12	18	M16	70	10,8	142 23 28
300	323,9	7,1	440	395	22	62	12	22	M20	80	14,0	142 23 36
350	355,6	7,1	490	445	22	62	12	22	M20	80	16,1	142 23 51
400	406,4	7,1	540	495	22	65	16	22	M20	80	18,3	142 23 77
500	508,0	7,1	645	600	24	68	20	22	M20	80	24,6	142 24 01

#### Enligt SS 2032 PN 10

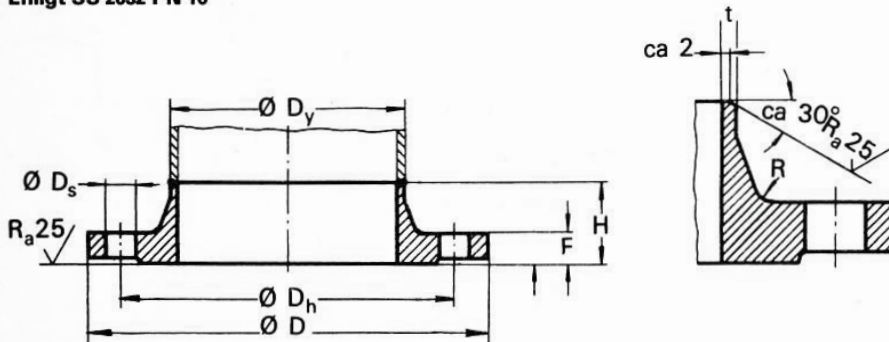

Ansl DN	Dy mm	t mm	D mm	Dh mm	F mm	H mm	Skruvhål st	Ds mm	Skruv gänga	Skruv längd/mm	Vikt kg/st	RSK-nr
<b>■ Av stål C 22.8 eller R St 37.2</b>												
200	219,1	6,3	340	295	24	62	8	22	M20	75	11,3	142 27 81
250	273,0	6,3	395	350	26	68	12	22	M20	80	14,7	142 28 23
300	323,9	7,1	445	400	26	68	12	22	M20	80	17,6	142 28 31
350	355,6	7,1	505	460	26	68	16	22	M20	80	21,4	142 28 56
400	406,4	7,1	565	515	26	72	16	26	M24	90	26,1	142 28 72
500	508,0	7,1	670	620	28	75	20	26	M24	90	34,7	142 29 06

## Svetsflänsar med krage — forts.

Certifikat kan om så önskas erhållas på flänsar PN 10, PN 16, PN 25, PN 40, PN 64 och PN 100. Detta måste i så fall begäras vid beställningstillfället.  
— forts.

### Enligt SS 2033 PN 16

Ansl DN	Dy mm	t mm	D mm	Dh mm	F mm	H mm	Skruvhål st	Ds mm	Skruv gänga	Skruv längd/mm	Vikt kg/st	RSK-nr
■ Av stål C 22.8												
10	17,2	1,8	90	60	14	35	4	14	M12	50	0,6	142 30 29
15	21,3	2,0	95	65	14	35	4	14	M12	50	0,7	142 30 45
20	26,9	2,3	105	75	16	38	4	14	M12	50	1,0	142 30 60
25	33,7	2,6	115	85	16	38	4	14	M12	50	1,1	142 30 86
32	42,4	2,6	140	100	16	40	4	18	M16	60	1,7	142 31 02
40	48,3	2,6	150	110	16	42	4	18	M16	60	1,9	142 31 28
50	60,3	2,9	165	125	18	45	4	18	M16	60	2,5	142 31 44
65	76,1	2,9	185	145	18	45	4	18	M16	60	3,1	142 31 51
80	88,9	3,2	200	160	20	50	8	18	M16	65	3,7	142 31 69
100	114,3	3,6	220	180	20	52	8	18	M16	65	4,6	142 32 19
125	139,7	4,0	250	210	22	55	8	18	M16	65	6,3	142 32 35
150	168,3	4,5	285	240	22	55	8	22	M20	75	7,8	142 32 50
200	219,1	6,3	340	295	24	62	12	22	M20	80	11,0	142 32 84
250	273,0	6,3	405	355	26	70	12	26	M24	80	15,6	142 33 26
300	323,9	7,1	460	410	28	78	12	26	M24	90	22,0	142 33 34
350	355,6	8,0	520	470	30	82	16	26	M24	90	28,7	142 33 59
400	406,4	8,0	580	525	32	85	16	30	M27	100	36,3	142 33 75
500	508	8,0	715	650	34	90	20	33	M30	100	59,3	142 34 09

### Enligt SS 2034 PN 25

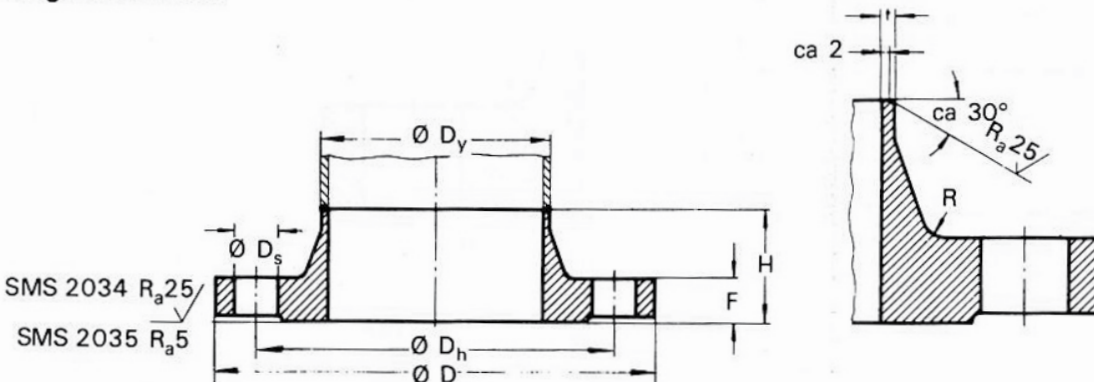

Ansl DN	Dy mm	t mm	D mm	Dh mm	F mm	H mm	Skruvhål st	Ds mm	Skruv gänga	Skruv längd/mm	Vikt kg/st	RSK-nr
■ Av stål C 22.8												
200	219,1	6,3	360	310	30	80	12	26	M24	90	17	142 37 89
250	273,0	7,1	425	370	32	88	12	30	M27	100	24,4	142 38 21
300	323,9	8,0	485	430	34	92	16	30	M27	100	31,2	142 38 39
350	355,6	8,0	555	490	38	100	16	33	M30	120	45,0	142 38 54
400	406,4	8,8	620	550	40	110	16	36	M33	120	58,7	142 38 70

### Enligt SS 2035 PN 40

Ansl DN	Dy mm	t mm	D mm	Dh mm	F mm	H mm	Skruvhål st	Ds mm	Pinnskruv gänga	Pinnskruv längd/mm	Vikt kg/st	RSK-nr
■ Av stål C 22.8												
10	17,2	1,8	90	60	16	35	4	14	M12	65	0,7	142 40 27
15	21,3	2,0	95	65	16	38	4	14	M12	65	0,8	142 40 43
20	26,9	2,3	105	75	18	40	4	14	M12	70	1,1	142 40 68
25	33,7	2,6	115	85	18	40	4	14	M12	70	1,3	142 40 84
32	42,4	2,6	140	100	18	42	4	18	M16	80	1,9	142 41 00

**STÅLMETALLFLÄNS FÖR LÖDNING**

Standard utförande, svart, utan ansats

Nominellt tryck PN 10 och PN 16

Rör ansl. nr	För utv. rör- diam	D	D <sub>h</sub>	F	Skruvhål Antal	d <sub>s</sub>	Vikt kg	Svart RSK	Galvade RSK
15	15	95	65	12	4	14,5	0,6	1485903	1485904
20	18	105	75	12	4	14,5	0,9	5929	5930
20	22	105	75	12	4	14,5	0,9	5937	5938
25	28	115	85	12	4	14,5	1,0	5945	5946
32	35	140	100	12	4	18,0	1,7	5952	5953
40	42	150	110	12	4	18,0	1,9	5978	5979
50	54	165	125	12	4	18,0	2,4	5986	5987
65	70	185	145	12	4	18,0	3,2	5994	5995
65	76,1	185	145	12	4	18,0	3,2	6000	6001
80	80	200	160	14	8	18,0	3,7	6018	6019
80	88,9	200	160	14	8	18,0	3,7	6042	6043
100	100	220	180	14	8	18,0	4,0	4856	4857
100	108	220	180	14	8	18,0	4,9	4872	4873
125	133	250	210	16	8	18,0	4,9	4880	4881
150	159	285	240	16	8	21,0	6,6	4898	4899
200	219	340	295	18	8	21,0	8,5	4890	4891

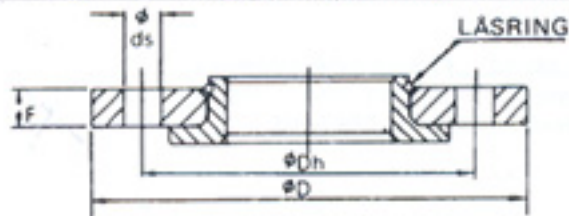

## Flänspackningar, guide

DIXO 4000 planpackning. T=1,5 mm

Art.nr	Ansl. DN	Tryckklass PN	Dim.
1504887	15	6	22x43
1504888	20	6	28x53
1504889	25	6	35x63
1504890	32	6	43x75
1504891	40	6	49x85
1504892	50	6	61x95
1504893	65/70	6	77x115
1504894	80	6	90x132
1504895	100	6	115x152
1504896	125	6	141x182
1504897	150	6	169x207
1504899	200	6	220x262
1504900	10	10-40	18x45
1504901	15	10-40	22x50
1504902	20	10-40	28x60
1504903	25	10-40	35x70
1504904	32	10-40	43x82
1504905	40	10-40	49x92
1504906	50	10-40	61x107
1504907	65/70	10-40	77x127
1504908	80	10-40	90x142
1504909	100	10-16	115x162
1504910	125	10-16	141x192
1504911	150	10-16	169x218
1504913	200	10-16	220x273
1504914	250	10-16	274x328
1504915	300	10	325x378